

## Sealing profile

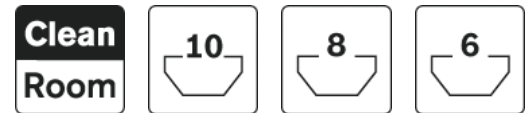

- For sliding and swing doors
- Prevents particles from entering or escaping
- Sealing profile N6 for use in cleanroom environments
- Two-piece seal also performs a stop function

# Product description

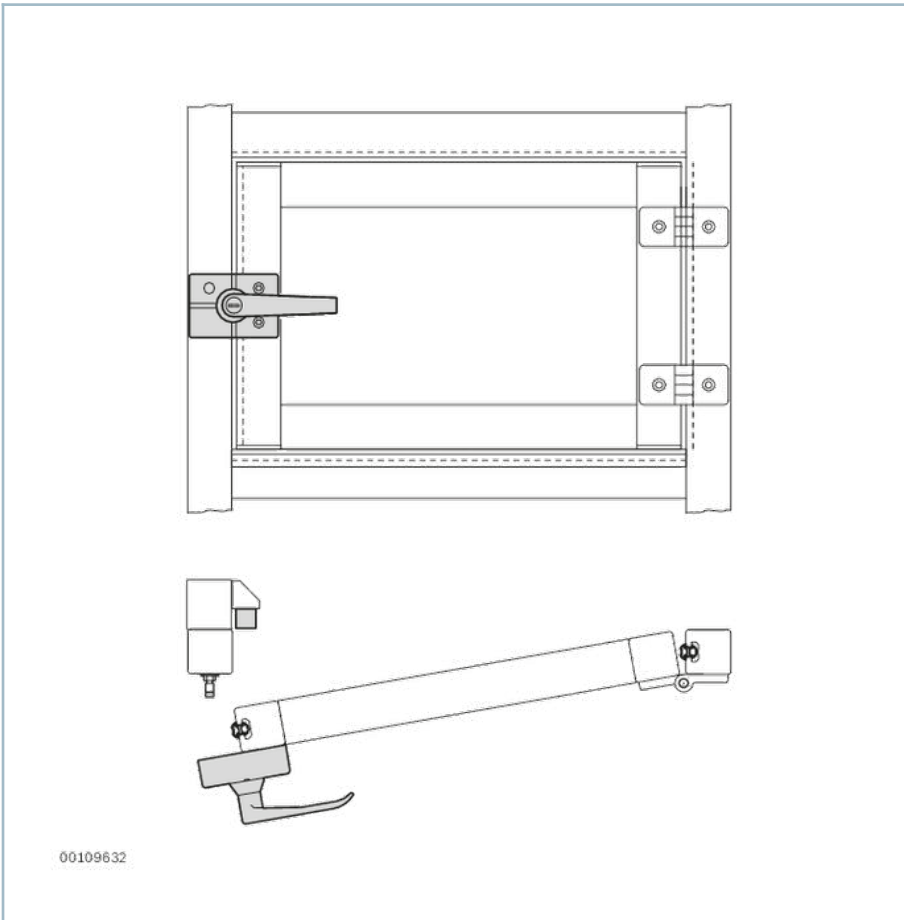
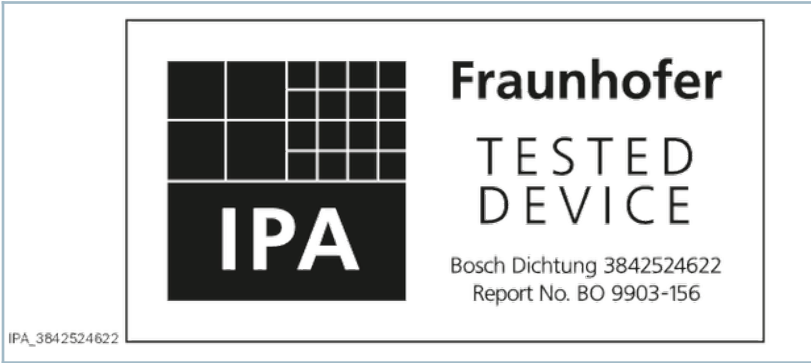

## Technical data

No.	Material
3842524623	TPE; light gray RAL 7035, Shore hardness A 64° ±5
3842524622	
3842516598	NBR; black, Shore hardness A 60°
3842518492	
3842554728	
3842554730	

## Dimensions

### Sealing profile N6

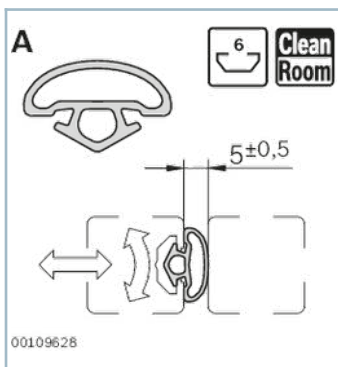

### Sealing profile N6, two-part

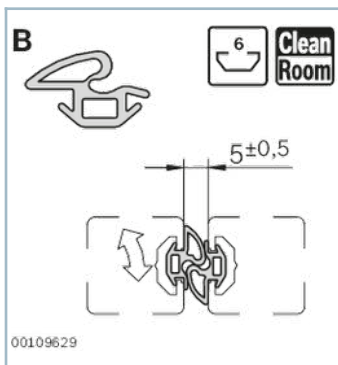

### Sealing profile N8

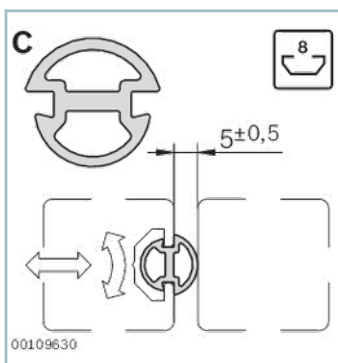

## Sealing profile N10

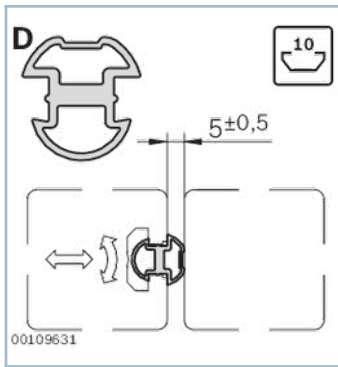

## Delivery notes

## Scope of delivery

Sealing profile N6
Sealing profile N6, two-part
Sealing profile N8
Sealing profile N10
Sealing profile N6
Sealing profile N6, two-part

## Ordering codes

	Groove	L	No.
		mm	
Sealing profile N6	6	10000	3842524623
Sealing profile N6, two-part	6	10000	3842524622
Sealing profile N8	8	10000	3842516598
Sealing profile N10	10	10000	3842518492
Sealing profile N6	6	10000	3842554728
Sealing profile N6, two-part	6	10000	3842554730