

Scharniere Hinges

Kunststoffscharniere Plastic Hinges

Kombischarniere Combi Hinges



KUNSTSTOFF-KOMBISCHARNIER 30

PLASTIC COMBI HINGE 30

Ausführung	aushängbar	Model	Detachable
Beschreibung	für Flächenelemente und Aluminiumprofile	Description	To hinge panels or aluminum profiles
Material	Flügel: Kunststoff PA, glasfaserverstärkt; Achse: Edelstahl	Material	Wings: Plastic PA, glass fiber reinforced; Axle: Stainless steel
Befestigung	vorderseitig mit Senkschrauben M6	Fastening	From the front, using M6 countersunk screws
Liefereinheit	10 Stück	Pack Quantity	10 pieces
Extras	⚡ elektrostatisch entladend, weitere Farben, Führungsnasen zur Montage auf Aluminiumprofilen auf Anfrage	Specials	⚡ electrostatically discharging, further colors, fixing pins for installation on aluminum profiles available on request

2

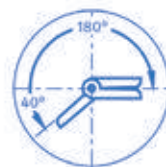
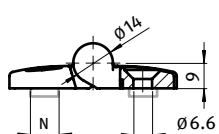
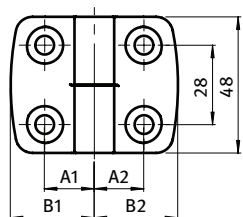

Scharnier Hinge	A1 [mm]	A2 [mm]	B1 [mm]	B2 [mm]	F _{Amax} [N]	F _{Rmax} [N]	N	Bezeichnung Description	Gewicht [g] Weight [g]	Teil-Nr. Part #
L: links Left	17.5	17.5	29.5	29.5	500	750		30/30	34.0	095K3030L00
	17.5	17.5	29.5	29.5	500	750	6	30/30	34.0	095K3030L06
	17.5	17.5	29.5	29.5	500	750	8	30/30	34.0	095K3030L08
	17.5	15.0	29.5	26.0	450	750		30/25	33.0	095K3025L00
	17.5	20.0	29.5	36.0	400	750		30/35	36.0	095K3035L00
	17.5	22.5	29.5	38.5	350	800		30/40	38.0	095K3040L00
	17.5	25.0	29.5	43.5	350	800		30/45	40.0	095K3045L00
	17.5	27.5	29.5	48.5	350	800		30/50	41.0	095K3050L00
R: rechts Right	17.5	17.5	29.5	29.5	500	750		30/30	34.0	095K3030R00
	17.5	17.5	29.5	29.5	500	750	6	30/30	34.0	095K3030R06
	17.5	17.5	29.5	29.5	500	750	8	30/30	34.0	095K3030R08
	15.0	17.5	26.0	29.5	450	750		30/25	33.0	095K3025R00
	20.0	17.5	36.0	29.5	400	700		30/35	36.0	095K3035R00
	22.5	17.5	38.5	29.5	350	800		30/40	38.0	095K3040R00
	25.0	17.5	43.5	29.5	350	800		30/45	40.0	095K3045R00
	27.5	17.5	48.5	29.5	350	800		30/50	41.0	095K3050R00
	32.5	17.5	57.5	29.5	240	800		30/60	45.0	095K3060R00

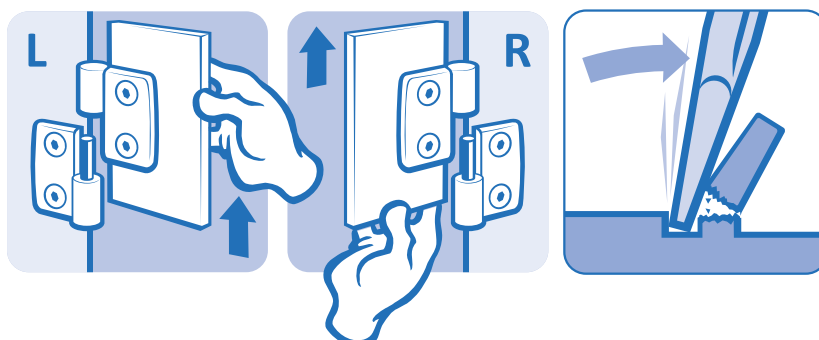

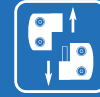

KUNSTSTOFF-KOMBISCHARNIER 40

PLASTIC COMBI HINGE 40

Ausführung aushängbar
Beschreibung für Flächenelemente und Aluminiumprofile
Material Flügel: Kunststoff PA, glasfaserverstärkt;
 Achse: Edelstahl
Befestigung vorderseitig mit Senkschrauben M6
Liefereinheit 10 Stück
Extras elektrostatisch entladend, weitere Farben,
 Führungsnasen zur Montage auf Aluminiumprofilen auf Anfrage

Model Detachable
Description To hinge panels or aluminum profiles
Material Wings: Plastic PA, glass fiber reinforced;
 Axle: Stainless steel
Fastening From the front, using M6 countersunk screws
Pack Quantity 10 pieces
Specials electrostatically discharging, further colors,
 fixing pins for installation on aluminum profiles available on request

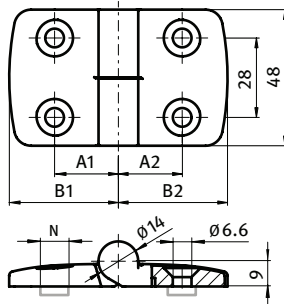

Kombischarnier Combi Hinge	A1 [mm]	A2 [mm]	B1 [mm]	B2 [mm]	F _{Amax} [N]	F _{Rmax} [N]	N	Bezeichnung Description	Gewicht [g] Weight [g]	Teil-Nr. Part #
L: links <i>Left</i>	22.5	22.5	38.5	38.5	400	800		40/40	42.0	095K4040L00
	22.5	22.5	38.5	38.5	400	800	8	40/40	42.0	095K4040L08
	22.5	22.5	38.5	38.5	400	800	10	40/40	42.0	095K4040L10
	22.5	15.0	38.5	26.0	425	650		40/25	37.0	095K4025L00
	22.5	17.5	38.5	29.5	500	750		40/30	38.0	095K4030L00
	22.5	20.0	38.5	36.0	400	750		40/35	40.0	095K4035L00
	22.5	25.0	38.5	43.5	350	800		40/45	43.0	095K4045L00
R: rechts <i>Right</i>	22.5	27.5	38.5	48.5	350	800		40/50	45.0	095K4050L00
	22.5	32.5	38.5	57.5	240	800		40/60	49.0	095K4060L00
	22.5	22.5	38.5	38.5	350	800		40/40	42.0	095K4040R00
	22.5	22.5	38.5	38.5	350	800	8	40/40	42.0	095K4040R08
	22.5	22.5	38.5	38.5	350	800	10	40/40	42.0	095K4040R10
	15.0	22.5	26.0	38.5	425	650		40/25	37.0	095K4025R00
	17.5	22.5	29.5	38.5	500	750		40/30	38.0	095K4030R00
	20.0	22.5	36.0	38.5	400	750		40/35	40.0	095K4035R00
	25.0	22.5	43.5	38.5	350	800		40/45	43.0	095K4045R00
	27.5	22.5	48.5	38.5	350	800		40/50	45.0	095K4050R00
32.5	22.5	57.5	38.5	240	800		40/60	49.0	095K4060R00	

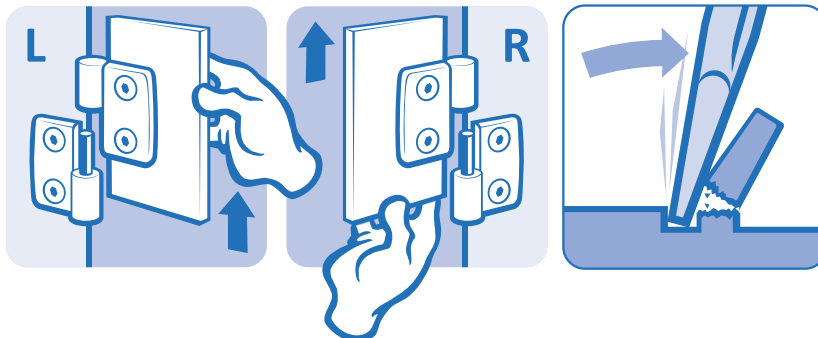

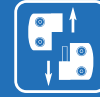

KUNSTSTOFF-KOMBISCHARNIER 45

PLASTIC COMBI HINGE 45

Ausführung aushängbar

Beschreibung für Flächenelemente und Aluminiumprofile

Material Flügel: Kunststoff PA, glasfaserverstärkt
Achse: Edelstahl

Befestigung vorderseitig mit Senkschrauben M6

Liefereinheit 10 Stück

Extras elektrostatisch entladend, weitere Farben, Führungsnasen zur Montage auf Aluminiumprofilen auf Anfrage

Model Detachable

Description To hinge panels or aluminum profiles

Material Wings: Plastic PA, glass fiber reinforced
Axle: Stainless steel

Fastening From the front, using M6 countersunk screws

Pack Quantity 10 pieces

Specials electrostatically discharging, further colors, fixing pins for installation on aluminum profiles available on request

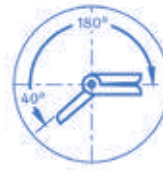
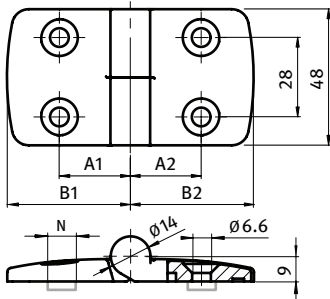

Kombischarnier Combi Hinge	A1 [mm]	A2 [mm]	B1 [mm]	B2 [mm]	F _{Amax} [N]	F _{Rmax} [N]	N	Bezeichnung Description	Gewicht [g] Weight [g]	Teil-Nr. Part #
L: links Left	25.0	25.0	43.5	43.5	325	800		45/45	45.0	095K4545L00
	25.0	25.0	43.5	43.5	325	800	8	45/45	45.0	095K4545L08
	25.0	25.0	43.5	43.5	325	800	10	45/45	45.0	095K4545L10
	25.0	15.0	43.5	26.0	425	650		45/25	38.0	095K4525L00
	25.0	17.5	43.5	29.5	500	750		45/30	40.0	095K4530L00
	25.0	20.0	43.5	36.0	400	700		45/35	42.0	095K4535L00
	25.0	22.5	43.5	38.5	350	800		45/40	43.0	095K4540L00
	25.0	27.5	43.5	48.5	320	800		45/50	46.0	095K4550L00
R: rechts Right	25.0	32.5	43.5	57.5	240	800		45/60	50.0	095K4560L00
	25.0	25.0	43.5	43.5	325	800		45/45	45.0	095K4545R00
	25.0	25.0	43.5	43.5	325	800	8	45/45	45.0	095K4545R08
	25.0	25.0	43.5	43.5	325	800	10	45/45	45.0	095K4545R10
	15.0	25.0	26.0	43.5	425	650		45/25	38.0	095K4525R00
	17.5	25.0	29.5	43.5	500	750		45/30	40.0	095K4530R00
	20.0	25.0	36.0	43.5	325	800		45/35	42.0	095K4535R00
	22.5	25.0	38.5	43.5	350	800		45/40	43.0	095K4540R00
27.5	25.0	48.5	43.5	320	800		45/50	45.0	095K4550R00	
32.5	25.0	57.5	43.5	240	800		45/60	50.0	095K4560R00	

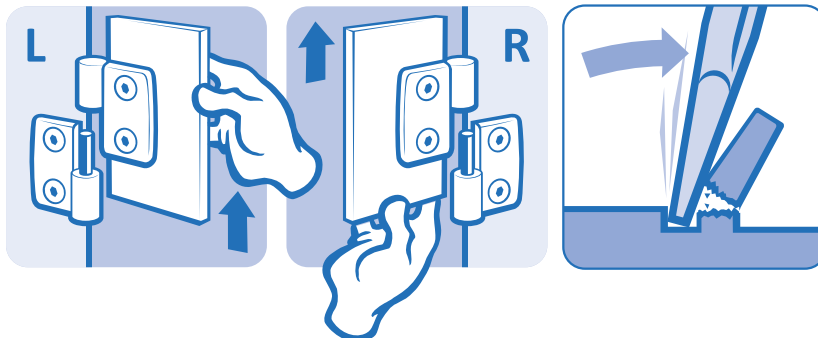

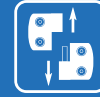

KUNSTSTOFF-KOMBISCHARNIER 60

PLASTIC COMBI HINGE 60

Ausführung	aushängbar	Model	Detachable
Beschreibung	für Flächenelemente und Aluminiumprofile	Description	To hinge panels or aluminum profiles
Material	Flügel: Kunststoff PA, glasfaserverstärkt Achse: Edelstahl	Material	Wings: Plastic PA, glass fiber reinforced Axle: Stainless steel
Befestigung	vorderseitig mit Senkschrauben M6	Fastening	From the front, using M6 countersunk screws
Liefereinheit	10 Stück	Pack Quantity	10 pieces
Extras	⚡ elektrostatisch entladend, weitere Farben, Führungsnasen zur Montage auf Aluminiumprofilen auf Anfrage	Specials	⚡ electrostatically discharging, further colors, fixing pins for installation on aluminum profiles available on request

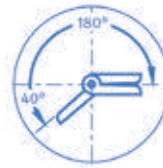
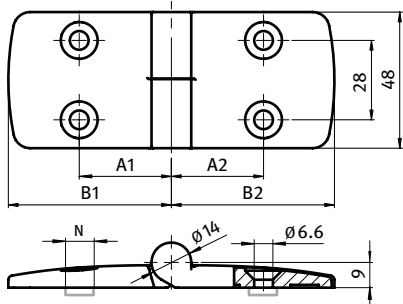

Kombischarnier Combi Hinge	A1 [mm]	A2 [mm]	B1 [mm]	B2 [mm]	F _{Amax} [N]	F _{Rmax} [N]	N	Bezeichnung Description	Gewicht [g] Weight [g]	Teil-Nr. Part #
L: links Left	32.5	32.5	57.5	57.5	240	900		60/60	55.0	095K6060L00
	32.5	32.5	57.5	57.5	240	900	8	60/60	55.0	095K6060L08
	32.5	32.5	57.5	57.5	240	900	10	60/60	55.0	095K6060L10
	32.5	15.0	57.5	26.0	425	650		60/25	43.0	095K6025L00
	32.5	17.5	57.5	29.5	500	750		60/30	45.0	095K6030L00
	32.5	20.0	57.5	36.0	400	700		60/35	47.0	095K6035L00
	32.5	22.5	57.5	38.5	350	800		60/40	49.0	095K6040L00
	32.5	25.0	57.5	43.5	325	800		60/45	50.0	095K6045L00
R: rechts Right	32.5	27.5	57.5	48.5	320	900		60/50	52.0	095K6050L00
	32.5	32.5	57.5	57.5	240	900		60/60	55.0	095K6060R00
	32.5	32.5	57.5	57.5	240	900	8	60/60	55.0	095K6060R08
	32.5	32.5	57.5	57.5	240	900	10	60/60	55.0	095K6060R10
	15.0	32.5	26.0	57.5	425	650		60/25	43.0	095K6025R00
	17.5	32.5	29.5	57.5	500	750		60/30	45.0	095K6030R00
	20.0	32.5	36.0	57.5	400	700		60/35	47.0	095K6035R00
	22.5	32.5	38.5	57.5	350	800		60/40	49.0	095K6040R00
25.0	32.5	43.5	57.5	325	800		60/45	50.0	095K6045R00	
27.5	32.5	48.5	57.5	320	900		60/50	52.0	095K6050R00	

